

V = 33 m³, A: 9.070 mm, E: 3.290 mm, B: 7.470 mm, F: 1.750 mm

Wywrotka aluminiowa tylnozsypowa - kłapa wewnętrzna

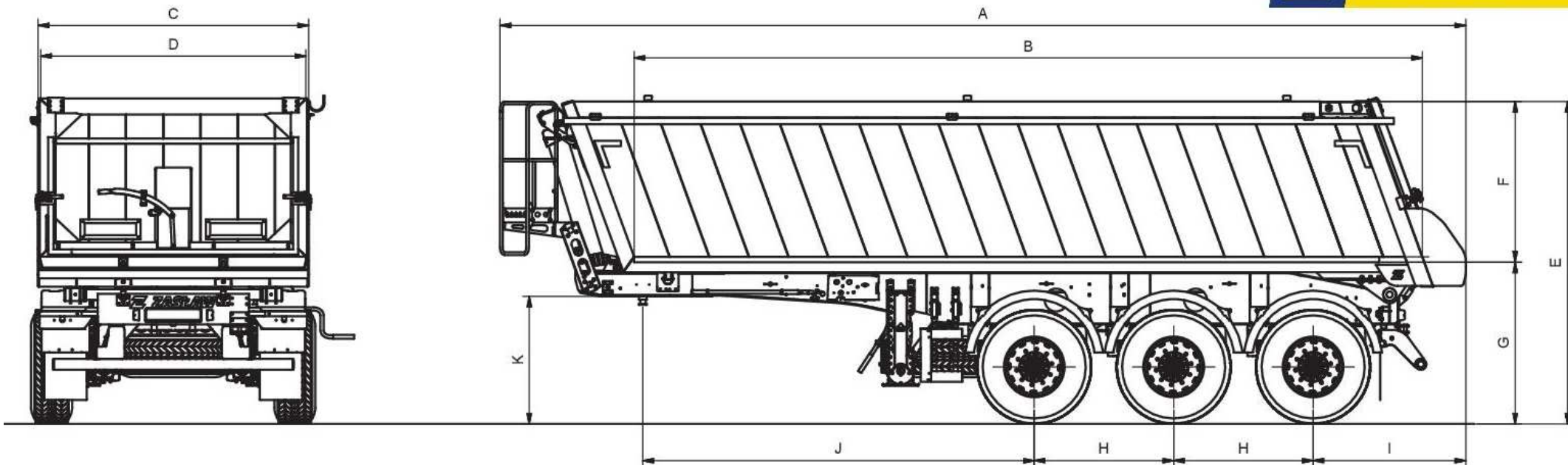

www.zaslaw-trails.pl / mail: info@zaslaw-trails.pl